



AKNAKODA
KVALITEET JA KOGEMUSED

Alljärgnevalt müügis olevad valmis **PVC-, puit-, alumiiniumaknad ja klaaspaketid**. Sobivusel võtke ühendust Teile lähima Aknakoda OÜ müügiesindusega või aknatehasega Pärnus Pärlimõisa tee 27 (tel. 44 56 238).

Seisuga 16.09.20

PVC - aknad ja ukсед

186047 A-1 - 16 Tk - maksumusega 85.00 tk

profiilid.....: LENG / RAAM EURO DESIGN 70 mm
Värv.....: VALGE
Klaas/täidis.....: 4kar-16arg-4karsel

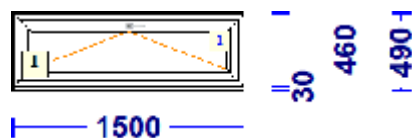

185808 A-3 - 1 Tk maksumusega 250.00

Profiilisüsteem REHAU
profiilid.....: LENG 72 / RAAM Z 59 SYNEGO
Värv.....: ANTRATSIITHALL / VALGE
Klaas/täidis.....: 4sel-16arg-4-18arg-4sel **PAKETT TELLIMISEGA! Tarne 1,5-2 nädalat**

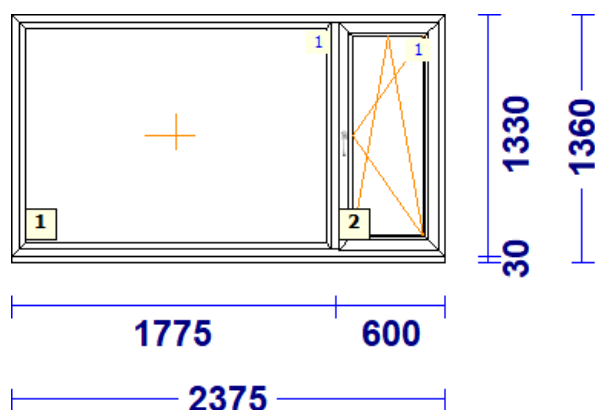



AKNAKODA

KVALITEET JA KOGEMUSED

310252 A-1 - 1 Tk - maksumusega 170.00

profiilid.....: LENG / RAAM EURO DESIGN 70 mm

Värv.....: VALGE

Klaas/täidis.....: 4-16arg-4sel **PAKETID TELLIMISEGA! Tarne 1,5-2 nädalat**

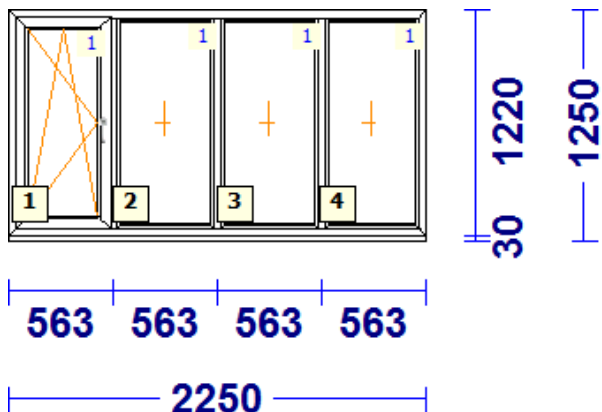

185859 - 1 Tk - maksumusega 250.00

Profiilisüsteem REHAU

profiilid.....: LENG 68 / RAAM Z 60 STANDARD THD.70

Värv.....: ANTRAZIITHALL7016/VALGE

Klaas/täidis.....: 4sel-12arg-4-16arg-4sel

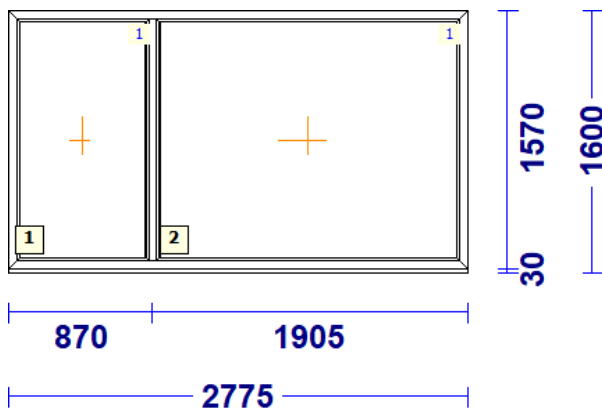

175199 A-12 - 1 Tk maksumusega 70.00

Profiilisüsteem REHAU

profiilid.....: LENG 72 / RAAM Z 59 SYNEGO

varustus.....: KLAASPAKETT + ALUSPROFIIL

Värv.....: KULDNE TAMM / VALGE

Klaas/täidis.....: 4sel-16arg-4-18arg-4sel **PAKETT TELLIMISEGA! Tarne 1,5-2 nädalat**

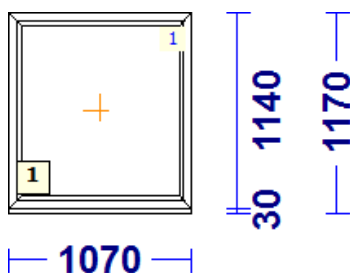



AKNAKODA

KVALITEET JA KOGEMUSED

310211 A-7 - 1 Tk - maksumusega 95.00 (kokku 2 tk)

profiilid.....: LENG 72 / RAAM Z 59 SYNEGO
Värv.....: ANTRATSIITHALL / VALGE
Klaas/täidis.....: 4sel-16arg-4-18arg-4sel

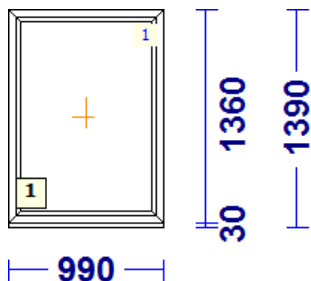

186039* A-1 - 1 Tk - maksumusega 210.00

profiilid.....: LENG 72 / RAAM Z 59 SYNEGO
Värv.....: ANTRATSIITHALL / VALGE
Klaas/täidis.....: 4sel-16THa-4-18THa-4sel

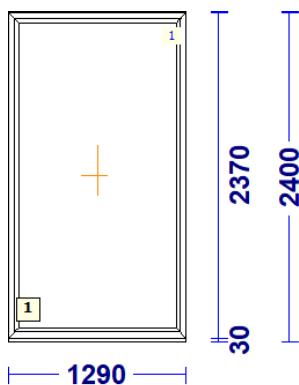

A-13 - 1 Tk - maksumusega 430.00 TALLINNA LAOS

Profiilisüsteem REHAU
profiilid.....: LENG / RAAM EURO DESIGN 70 mm
Värv.....: ANTRAZIITHALL / VALGE
Klaas/täidis.....: 6karsel-12a-4-12a-6karsel

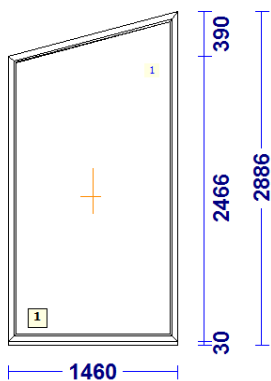



AKNAKODA

KVALITEET JA KOGEMUSED

115806 A-1 - 1 Tk - maksumusega 200.00 (kokku 2 tk)

Profiilisüsteem REHAU

profiilid.....: LENG / RAAM EURO DESIGN 70

Värv.....: **MUST / VALGE**

Klaas/täidis.....: 4sel-12arg-4-16arg-4sel

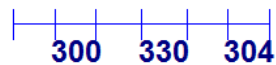
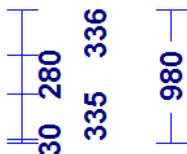
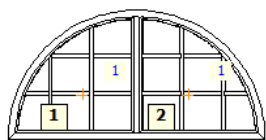

1 330 300 1

304



186039* RU-3 - 1 Tk - maksumusega 250.00

profiilid.....: LENG 72 / RAAM Z 59 SYNEGO

Värv.....: **ANTRATSIITHALL / VALGE**

Klaas/täidis.....: 4sel-16THa-4-18THa-4sel

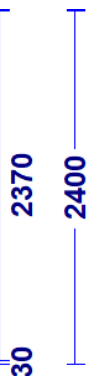
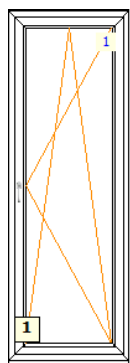

820



AKNAKODA

KVALITEET JA KOGEMUSED

186039* RU-4 LIITELEMENT! - 1 Tk - maksumusega 540.00

profiilid.....: LENG 72 / RAAM Z 59 SYNEGO
Värv.....: ANTRATSIITHALL / VALGE
Klaas/täidis.....: 4sel-16THa-4-18THa-4sel

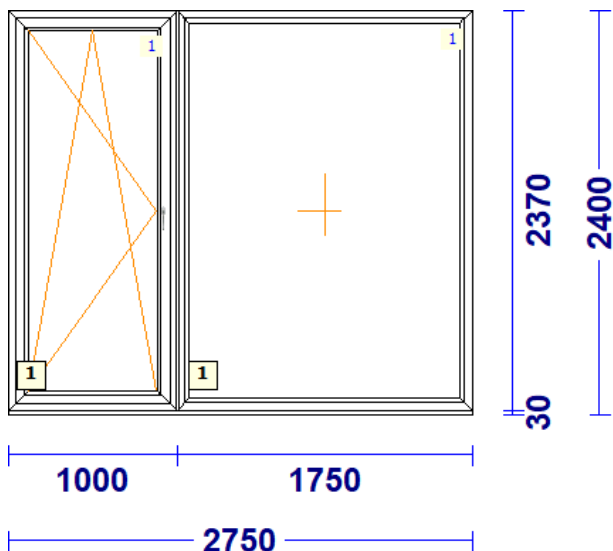

185993 RU-3 - 1 Tk - maksumusega 180.00

profiilid.....: LENG 72 / RAAM Z 59 ERIVÄRV SYNEGO
varustus.....: KLAASPAKETT + ALUSPROFIIL
Värv.....: HALL/RAL7004/VALGE
Klaas/täidis.....: 4sel-16arg-4-18arg-4sel

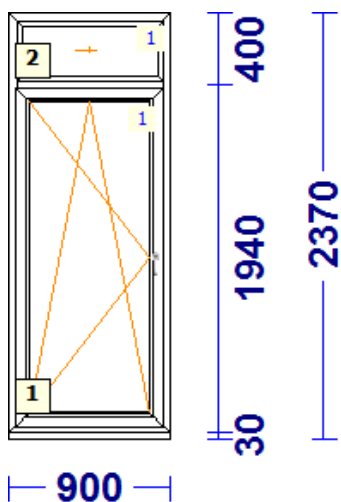



AKNAKODA
KVALITEET JA KOGEMUSED

145808 RU - 1 Tk - maksumusega 200.00

Profiilisüsteem REHAU

profiilid.....: LENG 72 / RAAM Z 59 SYNEGO

Värv.....: TUME TAMM/VALGE

Klaas/täidis.....: PVC-SYNEGO 48MM STAND/STAND

4sel-16arg-4-18arg-4sel **PAKETT TELLIMISEGA! Tarne 1,5-2 nädalat**

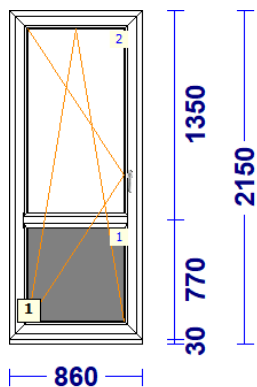

PVC AKNALAUAD 200mm sügavusega:

6jm (latt) – 33€ vajadusel mõõtu saagimisega (1€/tk)



Klaaspaketid **15 eur/tk**

2-kordsed	3-kordsed	MATTKLAAS	SYNEGO
429*1126 4tk	535*1734	1735*574 P	327*927
530*1093	526*1336	1214*574 P	410*610
309*659 jääkl.	554*1484	1754*574 P	594*590
	550*1960		994*704
	649*1849		1076*810
	1326*616		1960*550
	1008*385		1027*900
			387*1173
			804*1859
			1042*1317
			627*623
			1020*706 2tk
			1440*706
			773*403 crepi

NB! Klaaspakette väljastame ainult Pärnu tehase laost!